

PB21 | PB31

Mobile Receipt Printer



User Guide

Intermec by Honeywell
16201 25th Ave W
Lynnwood, WA 98087

The information contained herein is provided solely for the purpose of allowing customers to operate and service Intermec-manufactured equipment and is not to be released, reproduced, or used for any other purpose without written permission of Intermec Inc.

Information and specifications contained in this document are subject to change without prior notice and do not represent a commitment on the part of Intermec Inc.

Copyright © 2009–2016 Intermec, Inc., Honeywell International Inc. All rights reserved.

For patent information, see www.hsmpats.com.

Microsoft, Windows, and the Windows logo are registered trademarks of Microsoft Corporation in the United States and/or other countries.

Bluetooth is a trademark of Bluetooth SIG, Inc., U.S.A.

Wi-Fi is a registered certification mark of the Wi-Fi Alliance.

Document Change Record

This page records changes to this document. The document was originally released as Revision 001.

Version Number	Date	Description of Change
005	3/2016	Updated the printer voltage specification. Included information to support the new radio: <ul style="list-style-type: none">• Added the topic “Determining Which Radio Is Installed in Your Printer” and removed all specific procedures for configuring security.• Added the topic, “Differences in Wireless Communications Settings.”
004	4/2013	Updated the section about the card readers. Updated the procedure to set up Bluetooth communications. Added information about the AC18 charger to the troubleshooting table. Updated media specifications in Appendix A. Added the cleaning pen to the list of accessories.
003	5/2011	Revised battery information. Added procedures for configuring wireless network with PrintSet.
002	1/2010	Revised to add information for the magnetic stripe reader, smart card reader, and upgrading the firmware.

Contents

Before You Begin.....	ix
Safety Information.....	ix
Product Identification.....	ix
Contact Customer Support.....	ix
Warranty Information.....	x
Product Service and Repair.....	x
Send Feedback.....	x
Who Should Read This Manual.....	x

1 Using the PB21 and PB31 Mobile Receipt Printer..... 1

Introducing the PB21 and PB31 Mobile Receipt Printers.....	2
What's New.....	2
Identifying the Parts of the Printer.....	3
Understanding the Control Panel.....	3
Understanding the Printer Language.....	6
Changing the Printer Language.....	7
Understanding the Printer Sounds.....	9
Understanding the Backlight.....	10

Using the Batteries.....	10
Installing the Battery.....	11
Charging the Batteries.....	12
Understanding the Battery Icons.....	13
Extending Battery Life.....	13

Loading Media.....	14
--------------------	----

Using the Card Readers.....	16
Using the Magnetic Stripe Reader.....	16
Using the Smart Card Reader.....	17

Understanding the Display Modes.....	19
Understanding Ready Mode.....	19
Understanding Information Mode.....	19
Understanding Pause Mode.....	20
Understanding Setup Mode.....	20
Understanding Error Mode.....	22
Understanding Test Mode.....	22
Changing Configuration Settings from the Display.....	24

Printing a Test Page.....	26
---------------------------	----

2 Configuring the PB21 and PB31 27

Connecting the Printer to Your PC	28
Connecting the Printer Through the USB Interface	28
Connecting the Printer Through the Serial Port	29
Connecting the Printer to Your Network	31
Setting Up Bluetooth Communications	31
Setting Up 802.11 Radio Communications	33
Determining Which Radio Is Installed in Your Printer	33
Setting Up the Printer for Wireless Communications Using PrintSet	34
Configuring the Printer Settings	34
Changing Wi-Fi Configuration Settings from PrintSet	35
Changing Configuration Settings Using the Command Line	35
Changing Configuration Settings from the Printer Home Page	35
Changing Configuration Settings Using SmartSystems	36
Upgrading the Firmware	36
Upgrading the Printer Firmware Using PrintSet	37
Upgrading the Printer Firmware Using the Printer Home Page	38
Upgrading Printer Firmware Using SmartSystems	41
Upgrading the Printer Firmware Using a Communications Program	41
Downloading Fonts and Graphics	44

3 Troubleshooting and Maintaining the PB21 and PB31 45

Troubleshooting the Printer	46
Contacting Product Support	46
Understanding Error Messages	46
Troubleshooting Printer Problems and Finding Solutions	48
Troubleshooting Communication Problems	50
Using the Line Analyzer in Fingerprint	50
Using Dump Mode in IPL	51
Resetting the Printer	52
Cleaning the Printer	52
Cleaning the Printhead	53
Cleaning the Platen Roller	54
Cleaning the Printer Exterior	54
Cleaning the Printer Media Compartment	55

A Specifications	57
Specifications	58
Interfaces	61
RS-232 Serial Interface	61
USB Interface	62
Differences in Wireless Communications Settings	63
Accessories	66
B Default Settings	69
Factory Default Settings (Fingerprint Printers)	70
Factory Default Settings (IPL Printers)	71
Factory Default Settings (ESC/P Printers)	72
C IPL and Fingerprint Setup Menus	75
IPL Setup Menu	76
Fingerprint Setup Menu	77
I Index	79

Contents

Before You Begin

This section provides you with safety information, technical support information, and sources for additional product information.

Safety Information

Your safety is extremely important. Read and follow all warnings and cautions in this document before handling and operating Intermec equipment. You can be seriously injured, and equipment and data can be damaged if you do not follow the safety warnings and cautions.

This section explains how to identify and understand warnings, cautions, and notes that are in this document.



Warning: A warning alerts you of an operating procedure, practice, condition, or statement that must be strictly observed to avoid death or serious injury to the persons working on the equipment.



A caution alerts you to an operating procedure, practice, condition, or statement that must be strictly observed to prevent equipment damage or destruction, or corruption or loss of data.



Note: Notes either provide extra information about a topic or contain special instructions for handling a particular condition or set of circumstances.

Product Identification

The machine labels are attached to the underside of the printer and contain information on type, model, serial number, and AC voltage. This document provides warnings regarding personal safety during operation of the printer.

Contact Customer Support

To search our knowledge base for a solution or to log in to the Technical Support portal and report a problem, go to www.hsmcontactsupport.com.

Before You Begin

For our latest contact information, see www.honeywellaidc.com/locations.

Warranty Information

To understand the warranty for your Honeywell product, visit the Honeywell website at www.honeywellaidc.com and click **Resources > Warranty**.

Product Service and Repair

Honeywell International Inc. provides service for all of its products through service centers throughout the world. To find your service center, go to www.honeywellaidc.com and select **Support > Contact Support > Service and Repair**. Contact your service center to obtain a Return Material Authorization number (RMA #) before you return the product.

To obtain warranty or non-warranty service, return your product to Honeywell (postage paid) with a copy of the dated purchase record.

Send Feedback

Your feedback is crucial to the continual improvement of our documentation. To provide feedback about this manual, please contact the Technical Communications department directly at ACSHSMTechnicalCommunications@honeywell.com.

Who Should Read This Manual

This user guide is for the person who is responsible for installing, configuring, and maintaining the PB21 and PB31 printers.

This guide provides you with information about the features of the PB21 and PB31, and how to install, configure, operate, maintain, and troubleshoot them.

1

Using the PB21 and PB31 Mobile Receipt Printer

Use this chapter to familiarize yourself with the PB21 and PB31 mobile receipt printer. This chapter contains these sections:

- **Introducing the PB21 and PB31 Mobile Receipt Printers**
- **Using the Batteries**
- **Loading Media**
- **Using the Card Readers**
- **Understanding the Display Modes**
- **Printing a Test Page**

Introducing the PB21 and PB31 Mobile Receipt Printers

The PB21 and PB31 are rugged mobile receipt printers that are designed for use with Intermec mobile computers, Intermec vehicle mount computers, and SF51 and SR61 scanners. The PB21 uses 50.8 mm (2 in) media and the PB31 uses 76.2 mm (3 in) media.

The PB21 and PB31 provide:

- print resolution of 203 dpi.
- print speeds of up to 101.6 mm per second (4 ips).
- 802.1 b/g or Bluetooth radio options.



Note: Unless otherwise noted, this manual uses the term “printer” to refer to both the PB21 and PB31 printers.

What’s New

This version of the user guide includes these changes:

- Added the topic “**Determining Which Radio Is Installed in Your Printer**” on page 33 and removed all specific procedures for configuring security.
- Added the topic, “**Differences in Wireless Communications Settings**” on page 63.

Identifying the Parts of the Printer

Use this illustration to familiarize yourself with some of the features of the printer.

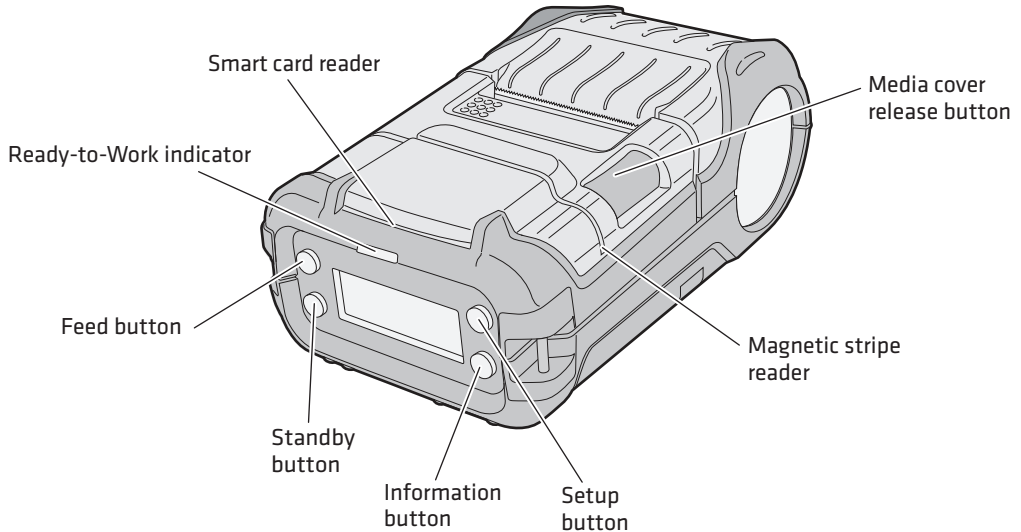

PB21 and PB31: This illustration shows the important features of the printer. A weather-resistant flap protects the communications ports and the external power connector.



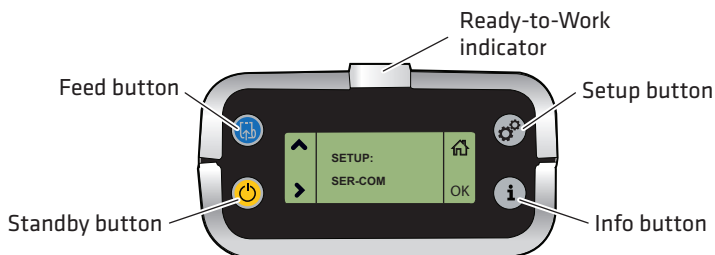

Understanding the Control Panel

The printer control panel contains four buttons, a liquid crystal display (LCD), and one LED indicator. Use the four buttons to navigate the menu system and perform functions on the PB21 and PB31 printer.







Printer Control Panel

How to Use the PB21 and PB31 Buttons

Name	Button	Function
Feed		<p>Press to advance the media. The amount of media that feeds is dependent on the type of media you are using. It will advance by 5 mm (0.2 inch), or feed a configured length of media based on your media and settings.</p> <p>If the printer is printing, pressing this button causes the printer to pause. Press the button again to resume printing.</p>
Setup		<p>Press to display the Setup menu. With ESC/P firmware, press and hold to cancel printing.</p>
Standby (Power)		<p>Press to put the printer in Standby mode. In Standby mode, power to the radio, the display, and the backlight are turned off.</p> <p>Press to turn the printer back on and put in Ready mode.</p>
Info		<p>Press to display a summary of network connection information and error conditions. Each setting in the summary information displays on the screen for five seconds.</p> <p>In Fingerprint and IPL, press this button in Pause mode to cancel the print job. The Info button is unavailable in ESC/P.</p>

All of the buttons can act as “soft keys,” which means that the function of each button depends on the state of the printer. A small icon appears in the screen next to the button to indicate the function it performs.

Understanding the Soft Keys

Button	Soft Keys	Description
	▲	<ul style="list-style-type: none"> Moves up one level in the menu system. This soft key appears in Setup mode.
	+	<ul style="list-style-type: none"> Increases the value of a number when editing settings such as an IP address. This soft key appears in Setup mode.
		<ul style="list-style-type: none"> Pauses the printing job. This icon appears only when you are printing.
		Exit Setup mode and return to Ready mode.
		➤
	OK	<ul style="list-style-type: none"> Moves down one level in the menu system and saves changes to a setting.
	⊗	<ul style="list-style-type: none"> Exits a printing job or exits Information mode.

There is only one LED on the printer: the Ready-to-Work™ indicator.

Understanding the Ready-to-Work Indicator

Indicator State	Description
Off	One of several conditions: <ul style="list-style-type: none"> The printer is in Standby mode. The printer is in Info mode. The printer is in Setup mode.
On	The printer is turned on and operating.
Blinking	One of several conditions: <ul style="list-style-type: none"> The printer is out of paper. The media cover is open. There is a printer error that requires you to perform an action. For a list of possible problems, see “Troubleshooting the Printer” on page 46.

Understanding the Printer Language

Your printer comes with Intermec Printer Language (IPL), Fingerprint, ESC/P, ZSim, and the ability to run any of the printer command languages. The language you select affects the functionality of the printer and how you interact with it.

The printer displays the current firmware type and version in Ready mode.

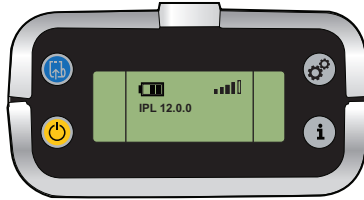

Printer Running IPL Firmware

The first time you turn on the printer, you select the printer language to run on the printer. The language you select automatically runs each time you turn on your printer.

To select the printer language

- 1 Turn on the printer.
- 2 Press the appropriate button to select a language.

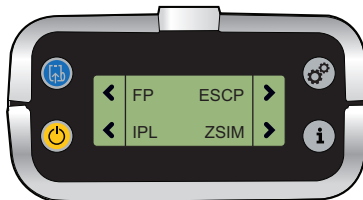

Changing the Printer Language

You can change the printer command language using PrintSet, the printer home page, a communications program like HyperTerminal, or the printer display.

To change the printer language using PrintSet

- 1 Connect your printer to your PC using a serial cable. For help, see [“Connecting the Printer Through the Serial Port” on page 29](#).
- 2 Start PrintSet. The Intermec PrintSet dialog box appears.
- 3 Under My Printers, click the printer you want to work with.
- 4 Click **Printer > Language Wizard**. The Language Wizard appears.
- 5 Follow the prompts for the Language Wizard to change the language for your printer.

To change the printer language using Fingerprint and a communications program

- 1 Connect your printer to your PC using a serial cable. For help, see [“Connecting the Printer Through the Serial Port” on page 29](#).
- 2 Start a communications program like HyperTerminal.
- 3 Send the enable administrator rights command:

```
run "su -p pass admin"
```
- 4 Send the run command to change the printer language to IPL:

```
setlanguage IPL -r
```

To change the printer language using IPL and a communications program

- 1 Connect your printer to your PC using a serial cable. For help, see [“Connecting the Printer Through the Serial Port” on page 29](#).
- 2 Start a communications program like HyperTerminal.
- 3 Send the enable administrator rights command:

```
<STX><ESC>.y, su -p pass admin <ETX>
```
- 4 Send the run command to change the printer language:

```
<STX><EXC> .y,setlanguage FP -r<ETX>
```

To change the printer language using ESC/P and a communications program

- 1 Connect your printer to your PC using a serial cable. For help, see **“Connecting the Printer Through the Serial Port” on page 29.**
- 2 Start a communications program like HyperTerminal.
- 3 Enter U-shell. Press the ESC key and type:
`{SYS:USH}`
- 4 Send the enable administrator rights command:
`su -p pass admin`
- 5 Send the run command to change the printer language:
`setlanguage IPL -r`

To change the printer language using the display and Fingerprint

- 1 Press the **Setup** button. The Setup menu system appears
- 2 Press **➤** until you reach **Print Defs.**
- 3 Press **OK** to enter the Print Defs menu system.
- 4 Press **➤** until you reach **CMD Language.**
- 5 Press **OK** to enter the CMD Language menu system.
- 6 Press **➤** until you see the language of you want to select.
- 7 Press **OK** to select the language.
- 8 Cold boot the printer:
 - a Remove the printer battery.
 - b Replace the printer battery.
 - c Turn the printer on.

To change the printer language using the display and IPL

- 1 Press the **Setup** button. The Setup menu system appears.
- 2 Press **➤** until you reach **Test/Service.**
- 3 Press **OK** to enter the Test/Service menu system.
- 4 Press **➤** until you reach **CMD Language.**
- 5 Press **OK** to enter the CMD Language menu system.
- 6 Press **➤** until you see the language of you want to select.

- 7** Press **OK** to select the language.
- 8** Cold boot the printer:
 - a** Remove the printer battery.
 - b** Replace the printer battery.
 - c** Turn the printer on.

To change the printer language using the display and ESC/P

- 1** Make sure the printer is in Ready mode.
- 2** Turn the printer off.
- 3** Open the media door.
- 4** Press and hold the **Feed** and **Power** buttons until the display shows “Close Printer Door.”
- 5** Press **▶** until you reach **CMD Language**.
- 6** Press **OK**.
- 7** Press and hold the **Power** button until the different command languages scroll automatically.
- 8** Press **OK** to select the printer language you want to select. The printer reboots automatically.

Understanding the Printer Sounds

The printer plays sounds when certain actions occur.

Understanding the Printer Sounds

Sound	Occurs When:
Power	<ul style="list-style-type: none">• You insert a battery in the printer.• The printer starts charging the battery.• You plug in the AC adapter.
Hardware	<ul style="list-style-type: none">• You open the media door.• You close the media door.• You insert a cable.
Button	You press any of the printer buttons.

Understanding the Printer Sounds (continued)

Sound	Occurs When:
Error	<ul style="list-style-type: none">• The printer cannot feed paper or print a job because of a hardware issue such as the media door open, a paper jam, or there is no media.• An error occurs such as a paper jam, a print error, or the printer is out of range.

Understanding the Backlight

The screen backlight on the printer behaves the same way as a screen saver on your PC. After a set amount of time elapses without any user interaction, the backlight goes off. The screen backlight turns on when:

- the printer begins printing.
- you press a button.
- you connect the printer to external power.
- you are communicating with or sending data to the printer.

You can change the amount of time to have elapse before the backlight turns off using the Setup menu. Options for backlight are always off, always on, 5 seconds, 10 seconds, 20 seconds, 30 seconds, or 60 seconds.

Using the Batteries

The printer uses a rechargeable 7.4 V 2300 mAh lithium-ion battery (Model AB27) for power. You must fully charge the battery before you can use the printer. The battery retains a charge for up to five days when the printer is in Standby mode.

A fully charged battery can usually print over 300 6-inch labels (PB31) or 500 6-inch labels (PB21) at 25% print density. When the printer reports low battery, it can usually print over 50 6-inch labels at 10% print density. The number of labels you can print varies depending on these factors:

- Age of the battery
- Temperature and humidity of the operating environment

- Printer configuration, including network connection settings
- Type of media loaded in the printer
- Amount of data printed for each label
- Threshold at which you configure the low battery warning



Use Intermec Model AB27 battery only. Use of another battery may present a risk of fire or explosion.

The Model AB27 battery may present a fire or chemical burn hazard if mistreated. Do not disassemble, heat above 100 °C (212 °F), or incinerate. Dispose of used batteries promptly. Keep away from children.

Installing the Battery

Make sure you fully charge the battery before you use your printer. You can charge the battery before or after you install them into the printer.

To install the battery

- 1** Lay the printer upside down on a flat surface.
- 2** Insert the battery with the tab facing away from the front control panel.

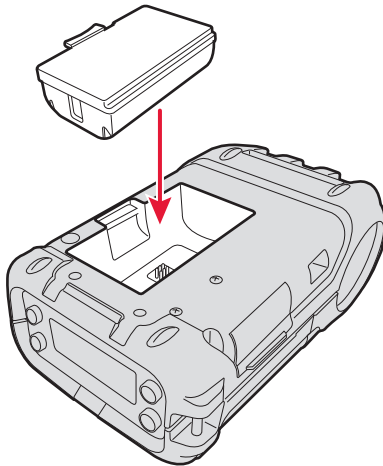

- 3 Insert the edge of the battery under the lip of the printer and then push down until you hear the battery latch click.

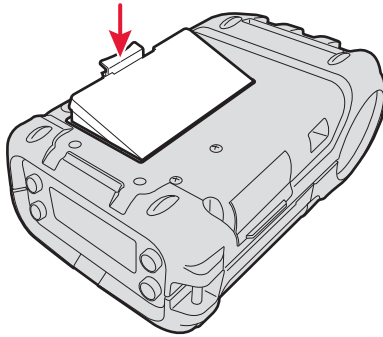

Charging the Batteries

There are two ways to charge the printer battery:

- Charge the battery in the AC18 4-bay battery charger. It takes approximately 4 hours to charge your batteries using the 4-bay battery charger. For more information, see the [AC18 4-Bay Battery Charger Instructions](#).
- Connect AC power to the printer using a 12 VDC power supply and charge the battery while it is in the printer. The battery takes approximately 3 hours to charge while it is installed in the printer.

To charge the battery inside the printer, you need:

- an Intermec 12 VDC power supply (Model AE19).
- an AC power cord.







To charge the battery inside the printer

- 1 Install the battery in the printer. For help, see the previous section, [“Installing the Battery” on page 11](#).
- 2 Connect the power supply to the DC power connector on the printer.
- 3 Connect one end of the power cord to the power supply and then plug the other end into an AC outlet.

Understanding the Battery Icons

The easiest way to tell the status of your battery is to look at the battery icons on the control panel of the printer.

Battery Icon Status

Icon	Status
	Battery is fully charged.
	Battery has a medium charge. You should be able to work for several more hours before charging or replacing the battery.
	Battery is low. Recharge the battery.
	Battery is critically low. You need to replace the battery now.
	Battery charging error. You may need to replace the battery.
	External power connected and there is no battery in the printer.

Extending Battery Life

Follow these guidelines to extend the overall life of your battery:

- Never expose the battery to direct sunlight or temperatures over 50 °C (122 °F).
- Only charge the battery inside the printer using a power supply or in the 4-bay battery charger (Model AC18).
- Do not set the backlight to always on. The always on setting disabled automatic power saving modes.

Follow these guidelines to extend the life of your battery between charges:

- Press the **Standby** button to put the printer in Standby mode.
- Remove the battery from the printer if you will not be using it for three days or more.

- Do not operate the printer when the ambient temperature is -20 °C (-4 °F) or below. Using the printer in temperatures below freezing reduces the overall battery life.



Note: Rechargeable batteries lose their ability to maintain a charge over time. You can only recharge a battery a finite number of times before you must replace it.

Loading Media

You can use roll or fanfold receipt media with the printer. The printer ships with a test page printed to verify that the printer works.

To load media

- 1 Press the blue media cover release button until the cover releases.

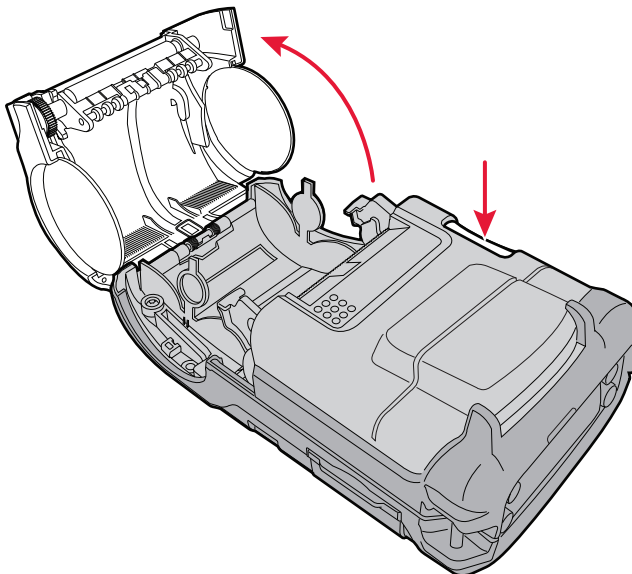

- 2** Insert a roll of media. Make sure you load the media clockwise so that it pulls off the core from the bottom of the printer.

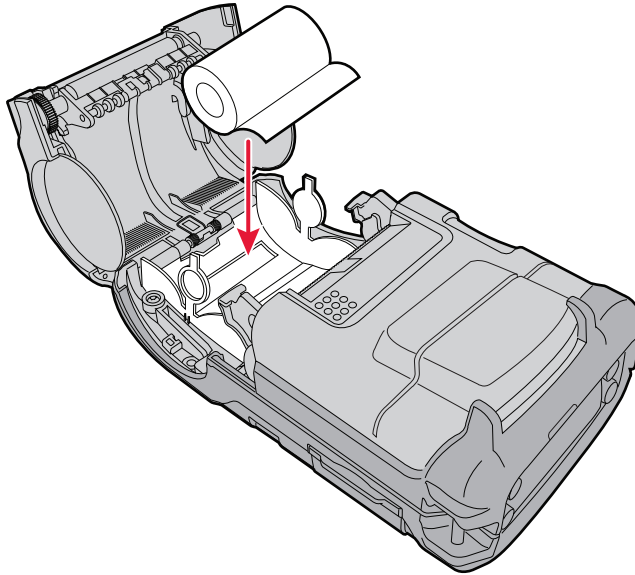

- 3** Pull out 8 cm (3 in) of the media, and then close the media cover.

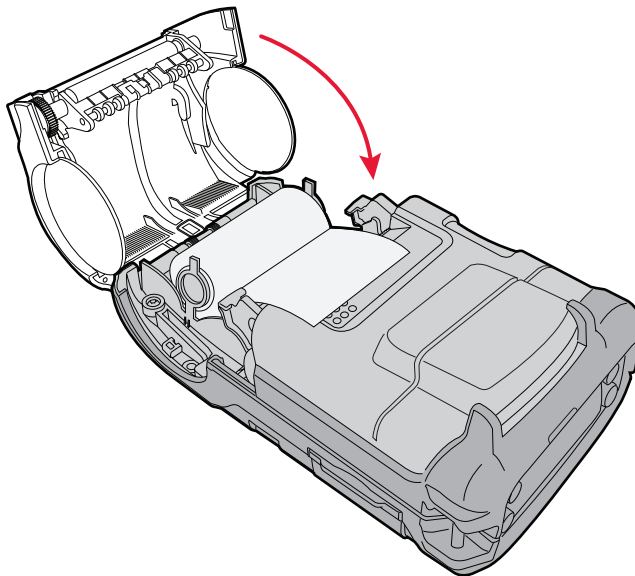

- 4** Press the **Feed** button to advance the media.

Using the Card Readers

Before you can use the magnetic stripe reader or the smart card reader, you need to take the necessary precautions to ensure PCI (Payment Card Industry) compliance and protect cardholder information.

To ensure PCI compliance

- 1 Enable encryption in the data collection application.



Note: The applications used to read card information must be certified. Work with a third-party partner to create a certified application. Or, download one of the Intermec Developer Library Resource Kits from www.intermec.com/idl, and then search the developers forum (www.intermec.com/support/developers_forum) for information about how to create certified applications.

- 2 Change the Bluetooth pin from the default value before pairing.
- 3 Make the Bluetooth printer undiscoverable.

Using the Magnetic Stripe Reader

You can use the magnetic stripe reader to send information encoded on a credit card or driver's license from your printer to your mobile computer.

To use the magnetic stripe reader

- 1 Set up a wireless connection between your printer and your Intermec mobile computer. For help, see “[Connecting the Printer to Your Network](#)” on page 31.
- 2 On your mobile computer, start an application that can read magnetic stripe data.

- 3 Place the readable end of the card against the reader, facing the media compartment.

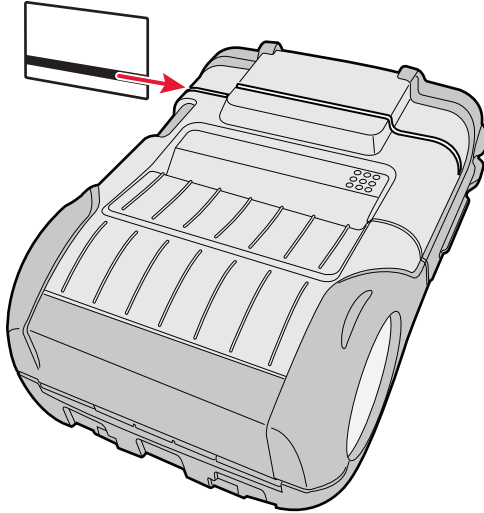

- 4 Swipe the card through the magnetic stripe reader.

Using the Smart Card Reader

You can use the smart card reader to read cards embedded with a smart card chip.

To use the smart card reader

- 1 Set up a wireless connection between your printer and your Intermec mobile computer. For help, see [“Connecting the Printer to Your Network” on page 31](#).
- 2 On your mobile computer, start an application that can read smart card information.

- 3** Orient the smart card with the chip facing the printer.

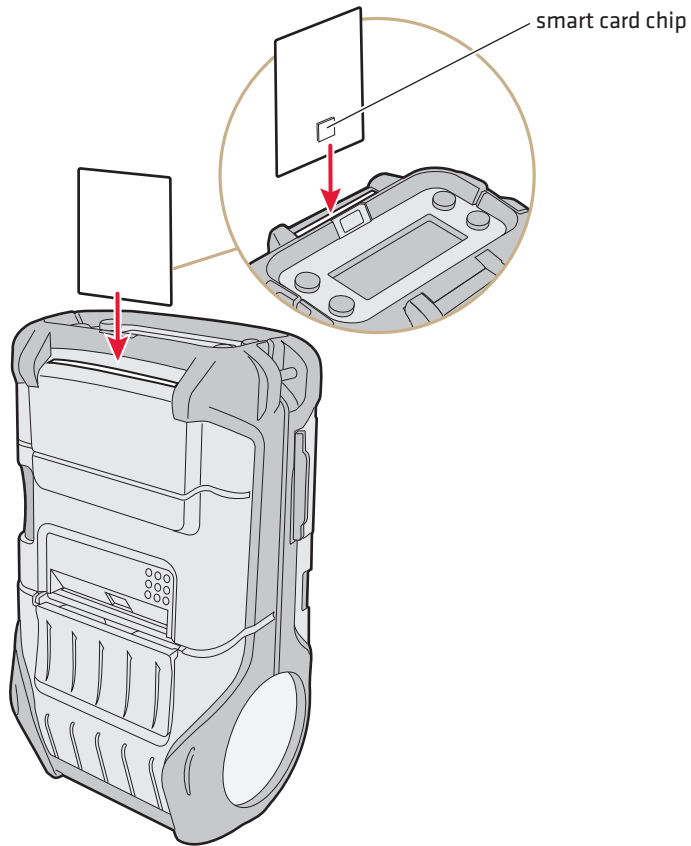

- 4** Insert the card into the smart card reader.

Understanding the Display Modes

The printer has six display modes to help you effectively interact with the printer: Ready, Information, Pause, Setup, Error, and Test.

Understanding Ready Mode

The printer is in Ready mode when the printer is on and ready to print. The main screen displays the power status, the radio status, and the printer language and version.

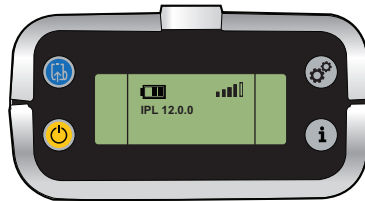

The PB21 and PB31 in Ready Mode

Understanding Information Mode

When the printer is in Information mode, it displays a subset of pertinent information about the printer. If the printer experienced an error, the error message displays first followed by the printer information. Each message displays on the screen for five seconds. After five seconds on the last information screen, the printer exits Information mode.

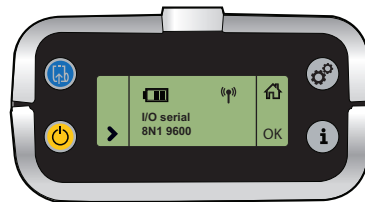

The PB21 and PB31 in Information Mode

To enter Information mode

- Press the **Information** button on the control panel.

Understanding Pause Mode

Use Pause mode to momentarily stop printing or to cancel a current print job. When you pause the printer, the Pause mode screen appears. Use the **Feed** button to both pause and resume printing.

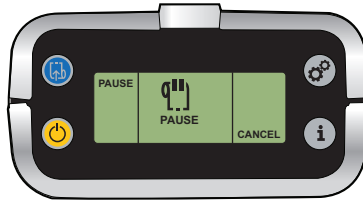

The PB21 and PB31 in Pause Mode

To enter Pause mode

- Press the **Feed** button while the printer is printing.

To resume printing

- Press the **Feed** button.

To cancel a print job

- 1 Press the **Feed** button to pause printing (Fingerprint, IPL, or ESC/P).
- 2 Press the **Information** button (or **X** soft key) to cancel the print job (Fingerprint or IPL) or press and hold the **Pause** button in ESC/P.

Understanding Setup Mode

Use Setup mode to change the settings on the printer.

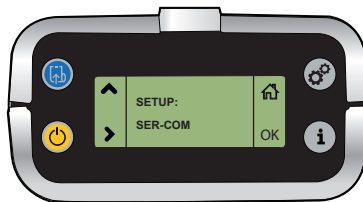

Sample Setup Mode Screen

To enter or exit Setup mode

- Press the **Setup** button.

After you enter Setup mode, there are two editing modes: normal and enhanced.

Editing Settings in Setup Mode

Editing Mode	To Navigate	To Accept Value
Normal	<ul style="list-style-type: none"> • Press ➤ to move among choices. • Press ⬆ to go up a level in menu system. 	Press OK .
Enhanced	<ul style="list-style-type: none"> • Press ➤ to move within the editable fields. When the field blinks, you can edit it. • Press + to increase the value of the field. 	Press OK .

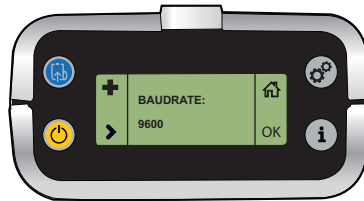

Normal Editing Mode: In normal editing mode, you see an up arrow and a right arrow for making selections.



Enhanced Editing Mode: In enhanced editing mode you have a plus sign and a right arrow to change the value of numeric fields.

Understanding Error Mode

The printer enters Error mode when it detects an error condition such as a low battery or a paper fault. Some error messages appear on the screen immediately when they occur, such as DOOR OPEN. Other error messages do not appear until you press the **Information** button. If there is more than one error at a given time, the errors display in the order that they occurred.

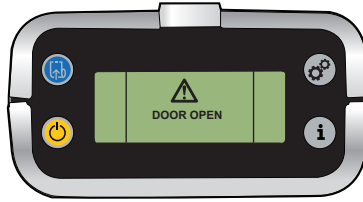

Sample Error Mode Screen

If you encounter an error message, see [“Understanding Error Messages” on page 46](#) for information on how to fix the problem.

Understanding Test Mode

Use Test mode to verify printer settings, test printing, restore factory default settings, or enter Dump mode for troubleshooting purposes. Two test modes are available: Test mode and Extended Test mode.

Using Test Mode

Test mode is a simple sequence of events which requires little user interaction. Extended Test mode requires more user interaction and lets you select which actions you want the printer to perform.

To enter Test mode

- 1 Make sure the printer is in Ready mode and is loaded with media.
- 2 Press the **Feed** and **Standby** buttons at the same time and hold until Select Media appears on the screen and it displays the type of media you are using.

- 3 Release both buttons. The printer performs a test feed (sensor calibration), prints, and then enters Dump mode.

The printer is now in Dump mode and it scans the communication ports. Any characters received on the communication ports are printed.

- 4 Press **Feed** to exit Dump mode.

After you exit Dump mode, the printer returns to Ready mode. For more information on Dump mode, see “**Troubleshooting Communication Problems**” on page 50.

Using Extended Test Mode

Use Extended Test mode to run additional diagnostic tests, entering Dump mode, and resetting to factory defaults.



Sample Extended Test Mode Screen

To enter Extended Test mode

- 1 Make sure that the printer is loaded with media.
- 2 Press the media cover release button to open the media cover.
- 3 Press the **Standby** button to turn the printer off.
- 4 Press **Feed** and **Standby** buttons at the same time until CLOSE PRINTER DOOR appears on the screen.
- 5 Close the media cover. You are now in Extended Test mode:
 - Press **➤** to cycle through the options.
 - Press **OK** to select a test option.
 - Press **🏠** to exit Extended Test mode.

Options in Extended Test Mode

Function	Description
Select Media	This option is almost the same as the process in Test mode, except that the printer performs a slow test feed in Extended Test mode. This enables the printer to perform a slow sensor calibration which can help resolve mark detection problems.
Test Labels	This option allows you to print test labels one at a time. Press OK to print the next label.
Dump Mode	This options enters Dump mode. For more information on Dump mode, see “Troubleshooting Communication Problems” on page 50.
Factory Default	This option restores the factory default settings. Press OK to select this option and then follow the instructions on the screen.
Exit to Setup	This option exits Extended Test mode and puts the printer in Setup mode.
Exit	This option exits Extended Test mode

Changing Configuration Settings from the Display

You need to enter Setup mode before you can change configuration settings. For more information on entering Setup mode, see **“Understanding Setup Mode” on page 20.**

The top levels of the Setup menu are organized in a one-way loop. Each level has several sub-levels.

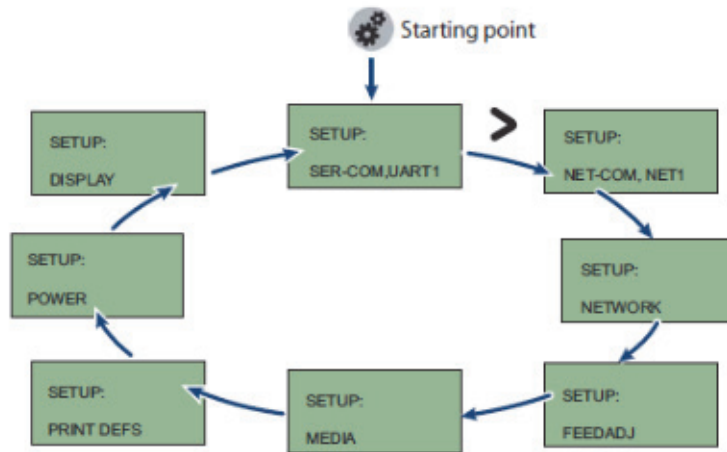

The Main Levels of the Setup Menu in Fingerprint

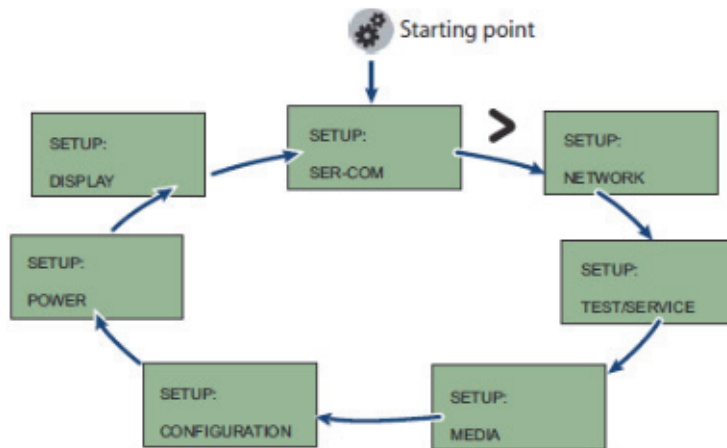

The Main Levels of the Setup Menu in IPL

ESC/P supports six types of setup commands:

- Bluetooth: set Bluetooth parameters
- Download: download fonts and graphics to the printer
- Easy print mode: print receipts, tickets, and reports
- Line printer mode: print receipts, tickets, and reports

- Query: retrieve information about the printer or a print request, cancel printing, or reset the printer
- Wi-Fi: set Wi-Fi parameters

Printing a Test Page

After you have loaded media in the printer, you are ready to print a test page. You can select from several test page options for each of the printer language. If you cannot get the test page information to print, see **“Troubleshooting the Printer” on page 46**.

To print a test page with a printer using IPL

- 1** Press the **Setup** button.
- 2** Press **▶** until you reach **Test/Service**.
- 3** Press **OK** to enter the Test/Service menu system.
- 4** Press **OK** to enter the Testprint Config menu.
- 5** Press **OK** to enter the Config menu.
- 6** Press **▶** to select a testprint.
- 7** Press **OK** to print the Config testprint of your choice.

To print a test page with a printer using Fingerprint

- 1** Press the **Setup** button.
- 2** Press **▶** until you reach **Print Defs**.
- 3** Press **OK** to enter the Print Defs menu system.
- 4** Press **▶** until you reach **Testprint**.
- 5** Press **OK** to enter the Testprint menu.
- 6** Press **▶** to select a testprint.
- 7** Press **OK** to print the testprint of your choice.

To print a self test with a printer using ESC/P

- 1** Press and hold the **Feed** and **Power** button simultaneously until the printer shows the media you are printing on.
- 2** Press the **Feed** button to exit Dump Mode.

2

Configuring the PB21 and PB31

This chapter contains these sections:

- **Connecting the Printer to Your PC**
- **Connecting the Printer to Your Network**
- **Configuring the Printer Settings**
- **Downloading Fonts and Graphics**

Connecting the Printer to Your PC

You can easily connect to the printer to your PC using one of these ports:

- USB port
- RS-232 serial interface port

Connecting the Printer Through the USB Interface

To connect the printer to a PC through the USB device port, you need:

- to install Intermec InterDriver® software. The latest version of InterDriver is available from the downloads page for the printer www.intermec.com/support/downloads/index.aspx.
- USB cable (P/N 321-611-xxx).

To connect the printer through a USB port

- 1 Run InterDriver.
- 2 The File Download - Security Warning screen appears. Click **Run** to run the executable.
- 3 The **Intermec End User License Agreement** appears. Read the agreement and select the radio button to accept the agreement, and then click **Next**.
- 4 The Installation Directory screen appears. The default installation directory is c:\Intermec\InterDriver7. Click **Next** to use the default directory or specify a different location to install the files.
- 5 The Installation Information screen appears. Clear the **Run Add Print Wizard after unpacking drivers** check box and click **Finish**.
- 6 On the New Hardware Wizard screen, select **Install from a list or specific location** and then click **Next** to continue.



Note: For LPT connections, you must restart your computer for Windows to detect the new hardware. For USB connections, the New Hardware Wizard will launch automatically when the printer is connected and turned on.

- 7 On the Search and Installation Options screen, click **Next**.

- 8 On the Hardware Installation warning screen, click **Continue Anyway**.
- 9 Click **Finish** to exit the New Hardware Wizard. InterDriver files are now installed on your computer.
- 10 Connect the USB cable to the connector on the back of the printer and connect the other end to your PC. You do not need to set up any parameters for USB communications.

Connecting the Printer Through the Serial Port

You can use a serial cable (P/N 075497) to communicate with your PC and run PrintSet, LabelShop, or InterDriver. You can also use the serial port to send commands directly to the printer through a communications program like HyperTerminal.

The serial communication parameters control the communication between the printer and the PC connected on the serial port, referred to as “uart1:” on the printer. Make sure the serial port settings on the printer match the settings on the connected device. The default serial communication settings on the printer are: 115200 baud rate, 8 data bits, no parity, 1 stop bit, and no flow control.

The serial cable you need is not included in the shipping box with the printer.

To connect the printer to a PC through the serial port using PrintSet

- 1 Connect the 8-pin circular DIN connector to the serial port on the printer. Connect the other end of the serial cable to a serial port on your PC.
- 2 Start PrintSet.
- 3 Click **File > Add printer**.
Or, in the **General Tasks** list, click **Add printer**.
- 4 Click **Next**.
- 5 Select **Serial**, and then click **Next**.
- 6 Make sure that the **COM Port** is set to the correct serial port, and that **Automatically detect communication parameters** is selected. Click **Next**.

- 7** PrintSet attempts to connect to your printer. If it cannot find your printer, click **Back** to review the communication settings, and then try again. When PrintSet connects to your printer, click **Next**.
- 8** Click **Finish**. Your printer appears in the **My Printers** list.

To connect the printer to a PC through the serial port using HyperTerminal

- 1** Connect the serial cable to the connector on the back of the printer and connect the other end to your PC.
- 2** On your PC, start the communications program.
- 3** If necessary, configure the port settings so they match those of your printer:

Bits per second: 115200

Data bits: 8

Parity: None

Stop bits: 1

Flow control: XON_XOFF

- 4** If you are using HyperTerminal:
 - a** Click **OK**.
 - b** Click the **Settings** tab.
 - c** Click **ASCII Setup**. The ASCII Setup window appears.
 - d** Select these check boxes, and then click **OK**:
 - **Send line ends with line feed**
 - **Echo typed characters locally**
 - **Append line feeds to incoming line ends**
- 5** Click **OK** to save and exit ASCII Setup.

6 To test your connection, type one of these commands in your communications program window:

- For IPL, press **Ctrl** and in the communications program window simultaneously type:

b, w, c

- For FingerPrint, type :

FF

and press **Enter**.

- For ESC/P, press the **ESC** key and type:

EZ {AHEAD:10}

The printer responds by feeding a small amount of media.

Connecting the Printer to Your Network

The printer provide two ways to connect to a network:

- Bluetooth radio communications
- 802.11 b/g radio communications

Setting Up Bluetooth Communications

The printer can contain a Bluetooth radio that allows wireless communications with a remote device from distances up to 100 meters (approximately 328 feet) depending on the Bluetooth range capabilities of the remote device, environmental conditions, and obstructions. For the Bluetooth-enabled devices to exchange data, both devices must establish a connection. Bluetooth software is always running in the background.

The printer cannot initiate a Bluetooth connection. One of the devices must request a connection with the printer. The printer then accepts or rejects the connection. Use Intermec Settings on the mobile computer to enable the Bluetooth settings on the printer.

The printer can also connect to Bluetooth scanners, such as the SF51 and the SR61. You can create the bar code labels you need to connect the printer to a Bluetooth scanner using EasySet software. You can download a free version of EasySet from the Intermec website at www.intermec.com.

Each printer equipped with a Bluetooth radio has a unique Bluetooth Device Address (BDA) loaded into its module when manufactured. You can find the BDA on the certification label located on the bottom of the printer.

To set up Bluetooth communications with a mobile computer

- Follow the procedure to discover and connect to Bluetooth devices in your mobile computer user manual.





Note: For maximum security, you need to configure a Bluetooth passcode for the printer. The default passcode for the PB21 and PB31 is “1234.”

To set up Bluetooth communications with a scanner

- 1 Download and install EasySet.
- 2 Create these bar code labels using EasySet:
 - Administrator reset factory defaults
 - Bluetooth parameters - security - not active
 - Bluetooth parameters - connect/disconnect - compose BT address
 - Bluetooth parameters - security - compose PIN
- 3 Scan the bar code labels with the Bluetooth scanner.

Understanding Bluetooth Radio Icons

Icon	Description
	The Bluetooth radio is on and the printer is not connected to a serial cable.
	The Bluetooth radio is turned off. The Bluetooth radio turns off when you connect a serial cable.

Setting Up 802.11 Radio Communications

The printer can have an internal 802.11 a/b/g radio to transfer and receive data using wireless communications. This manual assumes that you have already set up your wireless communications network including your access points.

To set up the printer to work in your wireless network, you need:

- serial cable (P/N 075497-xxx).
- a host PC running Windows or Linux.
- an active 802.11a/b/g wireless access point.
- a configuration application, such as PrintSet, or a communications application, such as HyperTerminal.



Note: If you are using IPL commands with HyperTerminal, you may want to be able to see the commands as you type them on your screen. For help, see [“Changing Configuration Settings Using the Command Line” on page 35](#).

- to know which radio is installed in your printer.

Determining Which Radio Is Installed in Your Printer

The available wireless communications settings depend on which radio is installed in your printer. For more information about differences in wireless communications settings, see [“Differences in Wireless Communications Settings” on page 63](#).

To determine which radio is installed in your printer

- Send this Fingerprint command to the printer:

```
run "wl ver"
```

The printer returns one of these output strings:

- current radio: 4.1 RC30.8
wl0: Feb 7 2006 15:21:43 version 4.1.30.8
- new radio: 4.1 RC30.8
1.1.5

Setting Up the Printer for Wireless Communications Using PrintSet

Use the PrintSet configuration application to set up wireless communications on your printer.

To set up the printer for wireless communications using PrintSet

- 1 Connect the printer to your PC using PrintSet. For help, see [“To connect the printer to a PC through the serial port using PrintSet” on page 29](#).
- 2 On your PC, start PrintSet.
- 3 Select your printer from the My Printers list.
- 4 In the **Printer Tasks** list, click **Wireless Setup Wizard**.
- 5 If prompted, type your username and password. The default username is `admin` and the default password is `pass`.
- 6 Click **Next**.
- 7 Follow the instructions to configure 802.11 radio communications and security.

Configuring the Printer Settings

You can change the printer configuration settings from:

- the display.
- the host PC using PrintSet.
- the host PC using the command line.
- the printer home page.
- SmartSystems™.

For more information about the IPL and Fingerprint menu systems, see [“IPL and Fingerprint Setup Menus” on page 75](#).

Changing Wi-Fi Configuration Settings from PrintSet

PrintSet is a printer configuration tool that you can download from the Intermec website. PrintSet can communicate with your printer through a serial cable or a network connection. It works on all PCs running Windows 98 (or later). PrintSet allows you to easily change all of the setup parameters. It also includes setup wizards to guide you through some common configuration tasks.

Changing Configuration Settings Using the Command Line

You can change configuration parameters by sending commands directly to the printer using a communications program like HyperTerminal and a serial or network connection.

If your printer is running Fingerprint, use the SETUP command, followed by the node, subnode, and parameters setting. Fingerprint automatically sends feedback to the communications program as you type. If your printer is running IPL, you need to change the HyperTerminal settings to see what you are typing.

To see IPL commands as you type

- 1 From the HyperTerminal menu, select **File > Properties > the Settings** tab.
- 2 Click the **ASCII Setup** button.
- 3 Select **Echo typed characters locally**.
- 4 Click **OK** twice.

Changing Configuration Settings from the Printer Home Page

If you have a printer with an 802.11 wireless radio, you can change configuration settings from the home page of the printer.

To make changes to the configuration

- 1 Establish a connection between your printer and the network. For help see [“Setting Up 802.11 Radio Communications” on page 33](#).
- 2 Connect your PC to the same network that the printer is on.
- 3 Change the printer language to Fingerprint or IPL. For help, see [“Changing the Printer Language” on page 7](#).

- 4** If you are using Fingerprint or IPL,
 - a** Press the **Setup** button .
 - b** Press the **▶** until you reach **Network**.
 - c** Press **OK** to enter the Network system menu.
 - d** Press **▶** until you reach **IP address**.
 - e** Press **OK** to view the IP address.
- 5** Start a web browser.
- 6** In the address field, type the IP address of your printer and press **Enter**. The home page of the printer appears.
- 7** Click Login and enter your administrator name and password.
- 8** On the home page of the printer, click **Configuration**.

For help with Fingerprint, IPL, ESC/P, or SmartSystems commands and information, see either the *Intermec Fingerprint Command Reference Manual*, the *Intermec Printer Language (IPL) Command Reference Manual*, the *ESC/P Programmer's Reference Manual* or SmartSystems online help. You can download these documents from the Intermec website at www.intermec.com.

Changing Configuration Settings Using SmartSystems

You can use the SmartSystems console to change configuration settings on your printer. The printer ships with the SmartSystems client loaded on it. The console is part of SmartSystems and is available from the Intermec website. To download SmartSystems, go to www.intermec.com/products/smrtsysfoundation/index.aspx.

Upgrading the Firmware

The latest firmware and software is available for download from the Intermec website at www.intermec.com. You can upgrade the firmware on your printer using:

- PrintSet. You can download PrintSet from the downloads page for the printer on the Intermec website at www.intermec.com.
- the printer home page.
- SmartSystems.

- a serial cable and a communications program, such as HyperTerminal.



When upgrading your firmware, make sure the battery in the printer is fully charged. If the printer loses power during the upgrade, the printer may be permanently damaged.

Upgrading the Printer Firmware Using PrintSet

You can only upgrade your printer using PrintSet when the printer is running IPL, Fingerprint, or ESC/P printer languages. To upgrade the printer using PrintSet, you need to install PrintSet on your PC and purchase a serial cable (P/N 075497).

- 1** If your printer is running ZSim or DSIm, change the printer language to IPL, Fingerprint, or ESC/P. For help, see **“Changing the Printer Language” on page 7.**
- 2** Connect your printer to your printer using a serial cable. For help, see **“Connecting the Printer Through the Serial Port” on page 29.**
- 3** Download the firmware upgrade file (.bin) to your PC:
 - a** Go to www.intermec.com.
 - b** Click **Support > Downloads.**
 - c** Use the **Product Category, Product Family, and Product fields**, to select the printer model.
 - d** Click **Submit.** The available software appears.
 - e** Download the latest firmware version to your PC.
 - f** Extract the .zip file to a folder on your PC.

- 4 Start PrintSet. The Intermec PrintSet dialog box appears.

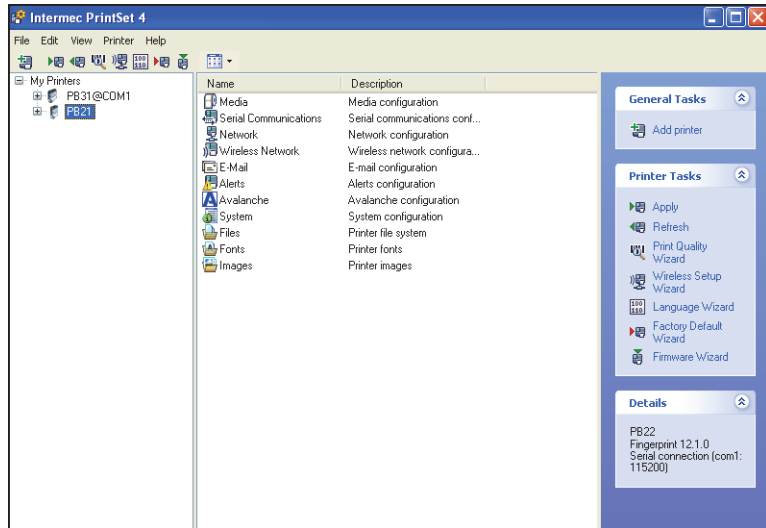

- 5 Under My Printers, click the printer whose firmware you want to upgrade.
- 6 Under Printer Tasks in the right-hand column, click **Firmware Wizard**.
- 7 Click **Next**. The Firmware Wizard dialog box appears.
- 8 Click **Browse** and navigate to the firmware upgrade file (.bin).
Wait approximately 5 minutes for the firmware upgrade to finish.

Upgrading the Printer Firmware Using the Printer Home Page

You can upgrade your printer using the printer home page with a printer with an 802.11 radio running IPL or Fingerprint.

To upgrade using the printer home page

- 1 Establish a connection between your printer and the network. For help, see [“Setting Up 802.11 Radio Communications” on page 33](#).
- 2 Establish a connection between your PC and the network your printer is on.

- 3** Download the firmware (.bin) file you want to upgrade to a location on your PC:
 - a** Go to www.intermec.com.
 - b** Click **Support** > **Downloads**.
 - c** Use the **Product Category**, **Product Family**, and **Product fields**, to select the printer model.
 - d** Click **Submit**. The available software appears.
 - e** Download the latest firmware version to your PC.
 - f** Extract the .zip file to a folder on your PC.
- 4** If you are using Fingerprint or IPL, use the display to find the printer's IP address:
 - a** Press the **Setup** button.
 - b** Press **▶** until you reach Network.
 - c** Press **OK** to enter the Network menu.
 - d** Press **▶** until you reach IP Address.
 - e** Press **OK** to select and view the IP Address.
 - f** Press the **Setup** button to exit.
- 5** Start a web browser.

- In the address field type the IP address of your printer and press **Enter**.

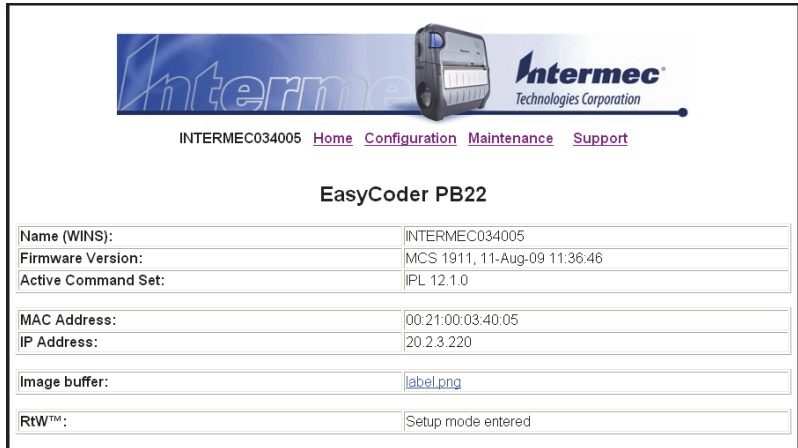

Name (WINS):	INTERMEC034005
Firmware Version:	MCS 1911, 11-Aug-09 11:36:46
Active Command Set:	IPL 12.1.0
MAC Address:	00:21:00:03:40:05
IP Address:	20.2.3.220
Image buffer:	label.png
RtW™:	Setup mode entered

- Click **Maintenance**.

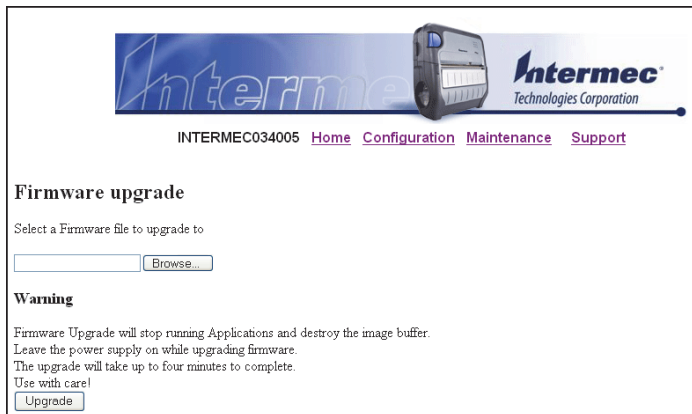

Firmware upgrade

Select a Firmware file to upgrade to

Warning

Firmware Upgrade will stop running Applications and destroy the image buffer.
Leave the power supply on while upgrading firmware.
The upgrade will take up to four minutes to complete.
Use with care!

- When prompted, enter your user name and password.
 - Browse to the firmware upgrade file (.bin) and select it.
 - Click **Upgrade**.
- Wait approximately 5 minutes for the firmware upgrade to finish. The printer automatically reboots.

Upgrading Printer Firmware Using SmartSystems

You can use the SmartSystems console to upgrade the printer firmware. Your printer ships with the SmartSystems client loaded on it. The console is part of SmartSystems and is available from the Intermec website. To download SmartSystems, go to www.intermec.com/products/smrtsysfoundation/index.aspx.

Upgrading the Printer Firmware Using a Communications Program

You can upgrade your printer firmware using a communications program, like HyperTerminal, and a printer running either the IPL, Fingerprint or ESC/P printer language.



Note: Intermec recommends using PrintSet or the printer home page to upgrade the printer firmware. For help, see [“Upgrading the Printer Firmware Using PrintSet” on page 37](#) or [“Upgrading the Printer Firmware Using the Printer Home Page” on page 38](#).

To upgrade the printer firmware using a communications program and IPL

- 1 Connect your printer to your PC using a serial cable. For help, see [“Connecting the Printer Through the Serial Port” on page 29](#).
Or,
Establish a connection between your printer and your network.
[“Connecting the Printer to Your Network” on page 31](#).
- 2 If you connected your printer to the network, establish a connection between your PC and the network your printer is on.
- 3 Download the firmware upgrade file (.bin) to your PC:
 - a Go to www.intermec.com.
 - b Click **Support** > **Downloads**.
 - c Use the **Product Category**, **Product Family**, and **Product fields**, to select the printer model.
 - d Click **Submit**. The available software appears.
 - e Download the latest firmware version to your PC.
 - f Extract the .zip file to a folder on your PC.

- 4 Start a communications program, like HyperTerminal.
- 5 Type this command:
`<STX><ESC>.y,ush<ETX>`
- 6 Press **Enter**. You are prompted to enter more information.
- 7 Type this command:
`su -p pass admin.`
- 8 Type this command:
`dlk -z`
The printer indicates that it is “Upgrading.”
- 9 In the communications program window, click **Transfer > Send File**. A dialog box appears.
- 10 In the protocol drop-down box, select **Zmodem**.
- 11 Browse to the firmware upgrade file (.bin) and select it.
Wait approximately 5 minutes for the firmware upgrade to finish. When the upgrade is complete, the communications program displays the message, “kernal flashing ok.” The printer automatically reboots.

To upgrade the printer firmware using a communications program window and Fingerprint

- 1 Connect your printer to your PC using a serial cable. For help, see “[Connecting the Printer Through the Serial Port](#)” on page 29.
- 2 Download the firmware upgrade file (.bin) to your PC:
 - a Go to www.intermec.com.
 - b Click **Support > Downloads**.
 - c Use the **Product Category**, **Product Family**, and **Product fields**, to select the printer model.
 - d Click **Submit**. The available software appears.
 - e Download the latest firmware version to your PC.
 - f Extract the .zip file to a folder on your PC.
- 3 Start a communications program, like HyperTerminal.

4 Type this command:

```
run "su -p pass admin"
```

5 Type this command:

```
run "dlk -z"
```

The printer indicates that it is “Upgrading.”

6 In the communications program window, click **Transfer > Send File**. A dialog box appears.

7 In the protocol drop-down box, select **Zmodem**.

8 Browse to the firmware upgrade file (.bin) and select it.

Wait approximately 5 minutes for the firmware upgrade to finish. When the upgrade is complete, the communications program window displays the message “kernal flashing ok.” The printer automatically reboots.

To upgrade the printer firmware using the communications program window and ESC/P

1 Connect your printer to your PC using a serial cable. For help, see **“Connecting the Printer Through the Serial Port” on page 29**.

2 Download the firmware upgrade file (.bin) to your PC:

a Go to **www.intermec.com**.

b Click **Support > Downloads**.

c Use the **Product Category**, **Product Family**, and **Product fields**, to select the printer model.

d Click **Submit**. The available software appears on the page.

e Download the latest firmware version to your PC.

f Extract the .zip file to a folder on your PC.

3 Start a communications program, like HyperTerminal.

4 Reboot the printer.

5 Press **Esc**.

6 Type this command:

```
{SYS:USH}
```

7 Type this command:

```
su -pass admin.
```

8 Type this command:

```
dlk -z.
```

The printer indicates that it is “Upgrading.”

9 In the communications program window, click **Transfer > Send File**. A dialog box appears.

10 In the protocol drop-down box, select **Zmodem**.

11 Browse to the firmware (.bin) upgrade file and select it.

Wait approximately 5 minutes for the firmware upgrade to finish. When the upgrade is complete, the communications program displays the message, “kernal flashing ok.” The printer automatically reboots.

Downloading Fonts and Graphics

The easiest way to download fonts and graphics is to use PrintSet. You can download PrintSet from the downloads page for the printer on the Intermec website at www.intermec.com. Follow the procedures in the PrintSet online help to download fonts and graphics.

For help with Fingerprint, IPL, ESC/P, or SmartSystems commands and information, see either the *Intermec Fingerprint Command Reference Manual*, the *Intermec Fingerprint Developer’s Guide*, the *ESC/P Programmer’s Reference Manual*, or SmartSystems online help. You can download these documents from the Intermec website at www.intermec.com.

3

Troubleshooting and Maintaining the PB21 and PB31

Use this chapter to solve problems you may encounter while using the PB21 and PB31. This chapter contains these sections:

- **Troubleshooting the Printer**
- **Resetting the Printer**
- **Cleaning the Printer**

Troubleshooting the Printer

You may have printer operation, print quality, or printer communication problems at some time during the life of the printer. It is easy to fix most of the problems and you will find solutions in “**Troubleshooting Printer Problems and Finding Solutions**” on [page 48](#). If you cannot find the answer to your problem, you may need to contact Product Support.

Contacting Product Support

Before you call Intermec Product Support, you may want to visit the Intermec technical knowledge base (Knowledge Central) at intermec.custhelp.com to review technical information or to request technical support. If you still need help after visiting Knowledge Central, you may need to call Product Support.

To talk to an Intermec Product Support representative in the U.S.A. or Canada, call:

1-800-755-5505

Outside the U.S.A. and Canada, go to www.intermec.com and click **Contact** to find your local Intermec representative.

Before you call Intermec Product Support, make sure you have this information ready:









- Printer serial number
- Firmware type and version
- Bluetooth, wireless, or serial port settings

You can find all of the information listed above in the printer menu system or on a test print page.

Understanding Error Messages

Use these tables to troubleshoot some common error message you may see on the printer screen. Some of the error messages are specific to the type of firmware you have loaded on your printer.

Possible Printer Error Icons and Messages

Error Icon	Error Message	Description
	Pause	The print job is paused.
	Paper out (IPL) Out of Paper (Fingerprint)	The printer is out of paper. Load a new roll of media. For help, see “Loading Media” on page 14 .
	Testfeed not done	The printer did not perform a test feed before printing. It is important to perform a test feed because it calibrates the sensor. To perform a testfeed: <ul style="list-style-type: none"> • In Fingerprint and ESC/P, press the Feed button for more than 1 second. • In IPL open and close the media door and then Press the Feed button.
	Printhead hot	The printhead is overheated and needs to cool down. In IPL, wait for printing to resume automatically. In Fingerprint and ESC/P, you need to restart your print job.
	Upgrading	The printer is loading new firmware.
	LSS too high, LSS too low	These errors can occur when you run a test feed without any media installed, or if you have incorrect media settings. Load the printer with media (see “Loading Media” on page 14), run Test mode (see “Understanding Test Mode” on page 22), and select the appropriate media type.
	IP configuration error	The printer is trying to acquire an IP address from the network. Wait for the printer to complete the task before taking any action.
	IP link error	No network connection.
	Field out of label	You are attempting to print in an area that extends beyond the print window. See the programmer’s reference manual for your type of firmware (IPL, Fingerprint, or ESC/P) for information on how to set the media parameters.

Possible Printer Error Icons and Messages (continued)

Error Icon	Error Message	Description
	Door open	The printer is not completely closed. Press down on the media cover to make sure it is latched.

Troubleshooting Printer Problems and Finding Solutions

Use this table to troubleshoot some common problems you may encounter with the printer.

Printer Problems and Solutions

Problem	Possible Solution
The printer does not turn on when you press Standby .	<ul style="list-style-type: none"> • Replace the battery with a charged battery. • Connect external power to make sure the printer works correctly and to charge the battery.
The blue light (Ready-to-Work indicator) is blinking.	<ul style="list-style-type: none"> • Make sure media is loaded and the media cover is closed. For help, see “Loading Media” on page 14. • There is a printing error. The screen displays an error message containing information on the error. • The printer is paused. The printer is cancelling a print job.
Printer keeps printing or feeding when it should stop.	<ul style="list-style-type: none"> • Check media settings.
The printout is not in the desired position.	<ul style="list-style-type: none"> • Check for errors in the software application.
The printer is not printing with an 802.11 wireless connection.	<ul style="list-style-type: none"> • Verify that the wireless settings are correct. For help, see “Setting Up 802.11 Radio Communications” on page 33. • Make sure the printer has an IP address. • Make sure the printer is connected to the network. • Make sure the printer is in Ready mode.

Printer Problems and Solutions (continued)

Problem	Possible Solution
The printer is not printing with a Bluetooth connection.	<ul style="list-style-type: none"> • Re-establish a Bluetooth connection with the mobile computer or scanner. For help, see your mobile computer user’s manual or “Setting Up Bluetooth Communications” on page 31. • Make sure the mobile computer can print to a known good printer. • Print a Bluetooth test print page to make sure that the mobile computer discovered your printer. For help, see “Printing a Test Page” on page 26. • Make sure the printer is in Ready mode.
Printout is faded or weak.	<ul style="list-style-type: none"> • Fingerprint users: adjust the media constant/factor and contrast (-10% to +10%). • IPL users: adjust the media sensitivity setting (-10 to +10). • ESC/P users: adjust the Media Sensitivity command or the Set Dark Adjust command. For help, see the <i>ESC/P Programmer’s Reference Manual.</i> • Check to see if the printhead needs cleaning. For help, see “Upgrading the Firmware” on page 36.
The battery charge is not lasting as long as it should.	<ul style="list-style-type: none"> • Check the battery date. If the battery is a few years old, the shortened life may be due to normal aging. • Replace the battery.
The AC18 4-bay battery charger is not charging the battery.	<ul style="list-style-type: none"> • Make sure that the battery is seated properly in the charger and the charging status light is on. For help, see the see the <i>AC18 4-Bay Battery Charger Instructions.</i> • Contact Intermec Product Support.
The test pages do not print.	<ul style="list-style-type: none"> • Make sure that the blue light is not blinking. If it is, make sure your printer has media and that the media cover is closed. • Make sure that you can advance media by pressing the Feed button.

Printer Problems and Solutions (continued)

Problem	Possible Solution
Print quality is poor.	<ul style="list-style-type: none">• Clean the printhead. For help, see “Upgrading the Firmware” on page 36.• Check the battery and recharge or replace as necessary. For help, see “Charging the Batteries” on page 12.• Check the quality of the media. Use only Intermec media to ensure superior print quality and product performance.• Check that the printer is set to the appropriate Constant/Factory or sensitivity number for the media you are using.

Troubleshooting Communication Problems

Use Dump mode to verify that the printer is receiving data from the host correctly.

Using the Line Analyzer in Fingerprint

In Dump mode, the printer runs a Fingerprint program called Line Analyzer. The Line Analyzer captures incoming characters on the communication ports and prints them.

The easiest way to enter Dump mode is through Test mode or Extended Test mode. For help, see [“Understanding Test Mode” on page 22](#).

After the printer enters Dump mode, it tells you it has entered Dump mode by printing it on a label. The display shows the Dump mode icon and printer is ready to receive data.

While the printer is receiving data, the Ready-to-Work indicator blinks. After a half of a second, if no more characters have been received, the printer times out. The program considers the transmission terminated and prints out a label.

Printable characters are printed in black-on-white. Control characters and space characters (ASCII 000 to 032 dec) are printed in white-on-black.

As long as a continuous string of characters is being received, the program wraps the lines until the label is full and then starts to print another label. After each character transmission, this information prints:

- Page number
- Number of characters printed on the label
- Total number of characters received so far

When you exit Dump mode, a final label prints to inform you that it is exiting from Dump mode.

Using Dump Mode in IPL

When you enter Dump mode, the printer captures incoming characters on the communication ports and prints them on one or more labels.

If you have IPL firmware on your printer, you can access Dump mode in two different ways with slightly different results:

- You can access Dump mode through Test mode or Extended Test mode and you will receive printouts that look exactly like those produced with the Line Analyzer program in Fingerprint. For more information, see the previous procedure, [“Using the Line Analyzer in Fingerprint” on page 50](#).
- You can access Dump mode from the Setup menu. If you access Dump mode this way, characters are printed on a continuous line along with corresponding hexadecimal numbers.

To enter Dump mode from the Setup menu

- 1 Press the **Setup** button.
- 2 Press **➤** until you reach **Test/Service**.
- 3 Press **OK** to enter the Test/Service menu.
- 4 Press **➤** until you reach **Data Dump** and then press **OK**.
- 5 Press **➤** to select Yes and then press **OK**.
- 6 Cold boot the printer to exit Dump mode. For help, see the next procedure, [Resetting the Printer](#).

Resetting the Printer

You rarely need to reset the printer, unless you are upgrading the firmware. If your printer occasionally locks up, you will want to reset it. A reset reinitializes the 802.11 radio and clears the working memory.



Note: The Setup menu is not affected by a reset. Your printer retains all of your configuration settings after the printer powers back up.

To reset the printer

- 1 Disconnect the printer from power if externally powered.
- 2 Remove the battery from the printer for at least one second.
- 3 Insert the battery back into the printer.
- 4 Reconnect external power if your printer is externally powered.

Cleaning the Printer

To properly maintain your printer, you must clean it at the recommended interval. Use the next illustration to locate the parts of your printer to clean.

Make sure to clean these parts:

- Printhead
- Platen roller
- Paper sensors
- Tear bar
- Printer exterior
- Media compartment



Warning

To avoid possible personal injury or damage to the printer, never insert any pointed or sharp objects into the printer.



Use only the cleaning agents specified in this section. Intermec is not responsible for damage caused by any other cleaning materials used on this printer.

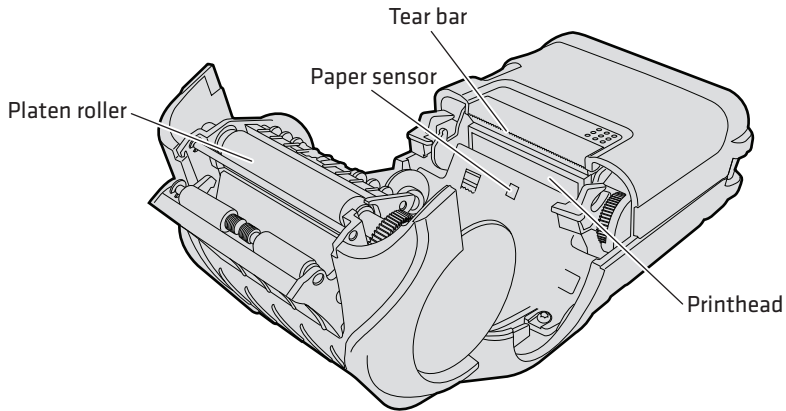

PB21 and PB31 Mobile Receipt Printer: You need to clean these parts regularly.

Cleaning the Printhead

Clean the printhead every five rolls of media to prolong the life of the printhead and ensures that you maintain high print quality.

Clean the printhead with the Intermec cleaning swab (P/N AE26034). The cleaning swab is shipped with the printer and can also be purchased separately from www.intermec.com.



Note: The Intermec cleaning swab is the recommended method for cleaning the printhead and platen roller. Using other methods for cleaning may damage the printer.

To clean the printhead

- 1 Open the media cover.
- 2 Remove the media and ribbon.
- 3 Use the cleaning swab or cleaning pen to dissolve any contamination on the line of heat-emitting objects at the front/ bottom of the printhead.
- 4 Wait 30 seconds and carefully rub off any contamination.

- 5 Repeat Steps 3 and 4 if necessary.
- 6 Allow the printhead to dry for a minute or more before loading a new supply of media and ribbon.

Cleaning the Platen Roller

Regular cleaning of the platen roller every five rolls of media prolongs the life of the printhead and ensures that you maintain high print quality.

Clean the platen roller with the cleaning swab provided by Intermec (P/N AE26034). The cleaning swab is shipped with the printer and can also be purchased separately from www.intermec.com.



Note: The cleaning swab is the recommended method for cleaning the printhead and platen roller. Using other methods for cleaning may damage the printer.

To clean the platen roller

- Rotate the platen roller and clean it thoroughly with the Intermec cleaning swab.

Be sure to clean these parts using the cleaning swab:

- Paper sensors
- Tear bar

Cleaning the Printer Exterior

Make sure to keep the exterior of the printer clean, this will reduce the risk of dust or foreign particles reaching the inside of the printer and affect printer functionality.

To clean the printer exterior

- 1 Close the media cover.
- 2 Use a soft cloth, possibly moistened with water or a mild detergent and wipe the printer exterior.

Make sure to keep the surface surrounding the printer clean, as well.

Cleaning the Printer Media Compartment

To clean the printer interior

- 1** Open the media cover.
- 2** Remove the media and ribbon.
- 3** Use a brush or air blow the compartment.
Make sure the paper sensors are free of dust.

A

Specifications

Specifications

This section lists the physical and environmental specifications for the printers.

PB21 Physical Dimensions

Depth:	71.1 mm (2.8 in)
Height:	176.4 mm (6.9 in)
Width:	101.6 mm (4.0 in)
Weight:	678 g (1.5 lb) with battery

PB31 Physical Dimensions

Depth:	81.6 mm (3.2 in)
Height:	182.2 mm (7.2 in)
Width:	127.6 mm (5.0 in)
Weight:	828 g (1.8 lb) with battery

Power Specifications

AC power adapter voltage:	100 to 240 V, 47 to 63 Hz
Printer voltage:	12 VDC, 4.0 A
Operating power:	Rechargeable 7.4 V 2300 mAh lithium-ion battery

Temperature and Humidity Specifications

Operating temperature:	-15 °C to 50 °C (-5 °F to 122 °F)
Storage temperature:	-30 °C to 70 °C (-22 °F to 158 °F)
Charging temperature:	0 °C to 45 °C (32 °F to 113 °F)
Relative humidity:	10 to 90% non-condensing
Sealing:	IP54 is used. Paper path and card reader slots are excluded from IP54.

Memory

RAM:	16 MB
Flash:	64 MB

Print Speed and Resolution

Print speed: 4 ips (100 mm/s)
Resolution: 203 dpi (8 dots/mm)

Print Technology

Printhead: Direct thermal
Maximum print width: PB21 48 mm (1.8 in)
PB31 72 mm (2.8 in)

Media Specifications

Minimum black mark length: 3.17 mm (0.125 in)
Black mark width: Full width of media
Core inside diameter: 19.05 mm (0.75 in)
Roll outside diameter: PB21 57.15 mm (2.25 in)
PB31 67.31 mm (2.65 in)
Tracking: Center
Maximum caliper for tags: 0.15 mm (0.006 in)
Minimum media length: 12.7 mm (0.5 in)
Maximum media length: Continuous

When you order printer media, keep these points in mind:

- Tag and fanfold media use black marks as repeat indicators for non-continuous media. Black marks are sensed on the side of the media that is thermally sensitive.
- You can use higher caliper media in the printer, but print quality will be reduced.
- Receipt roll stock media is supplied as a continuous roll and has an end of roll indicator. The end of roll indicator is a red marking (on last 3 feet of roll) on the side of the paper that is thermally sensitive.

External Fanfold Media Specifications

Stack height: 70 mm (2.75 in)
Page length: 152 mm (6 in) to 305 mm (12 in)



Note: A 6-inch page length is supplied in 12-inch long stacks (two 6-inch stacks of equal height with the bottom page linked).

Specialty media is required for unique customer environments, including printer operating temperature extremes. Intermec recommends that you test the media in your application.

Supported Media

The printer supports tag and receipt media. Receipt media is supported in both a top coated and an uncoated paper in continuous roll stock only.

The default media sensitivity number is 180. Use this table as a guide when setting sensitivity numbers.

Recommended Media Sensitivity and Constant

Sensitivity	Constant	Description
North America Receipt Media		
401	85	Duratherm TC
102	32	Duratherm NTC - 2
101	30	Duratherm NTC
104	80	Duratherm Receipt - Fanfold
103	100	Duratherm Linerless

Interfaces

This section describes the standard interfaces available on the PB21 and PB31 printers.

RS-232 Serial Interface

The serial adapter is an 8-pin DIN to DB9 connector that connects from the printer to your desktop PC.

Serial Port Default Settings

Parameter	Default Setting
Baud rate	115200
Character Length or Data Bits	8
Parity	None
Stop Bits	1
Handshaking	None (Fingerprint) XON/XOFF (IPL)

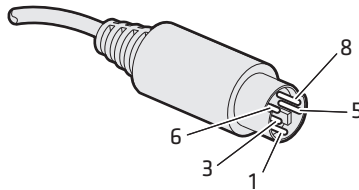

Serial Cable (Printer End)

Serial Cable Pinouts (Printer End)

Pin	Signal	Description
1	HHC RXD	Receive data from host (input)
3	HHC CTS	Clear to send from printer (output)
5	HHC RTS	Request to send from host (input)
6	HHC TXD	Transmit data to printer (output)
8	GND	Ground

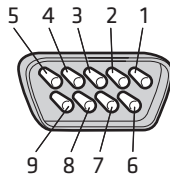

RS-232 Serial Cable DB9 Pins (PC End)

Serial Cable Pinouts (PC End)

Pin	Signal	Description
1	DCD	Data carrier detect
2	RXD	Receive data from host (input)
3	TXD	Transmit data to printer (output)
4	DTR	Data terminal ready
5	GND	Ground
6	DSR	Data set ready
7	RTS	Request to send from host (input)
8	CTS	Clear to send from printer (output)
9	RI	Ring indicator

USB Interface

To use the USB interface to print from a PC, you need to have the Intermec InterDriver printer driver installed on your PC. For help setting up USB communications, see [“Connecting the Printer Through the USB Interface” on page 28](#).

The USB cable that ships with the printer has a USB Type A connector on one end to connect to the PC and a USB Type B connector on the other end to connect to the printer. You do not need to configure communications for the USB port.

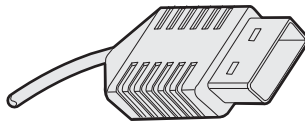

USB Type A Connector

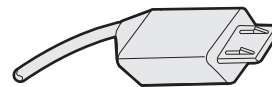

USB Type B Connector

Differences in Wireless Communications Settings

There are two 802.11 radios available for your printer. Some wireless communications settings differ depending on which radio is installed. To determine which radio is installed, see [“Determining Which Radio Is Installed in Your Printer” on page 33](#).

Wireless Communications Settings Differences

Setting	Current Radio	New Radio
AUTH	Specifies the security method the printer uses to grant access to the wireless network: <ul style="list-style-type: none"> • Open (default) • Shared • Auto 	Specifies the security method the printer uses to grant access to the wireless network. The only supported method is Open.
BAND	Not Supported	Configures the band in which the radio needs to be configured: <ul style="list-style-type: none"> • 2.4 GHz (default) • 5 GHz
CHANNEL	If you select Adhoc as the NETWORK TYPE, specifies the channel (from 1 through 14) over which to transfer data. Default: 1	If you select DIRECT as the MODE, specifies the channel (based on the .REGION and BAND settings) over which to transfer data. Default: 1 (DIRECT) for 2.4 GHz, 36 for 5 GHz
INNER_AUTH	For PEAP, TTLS, or EAP-FAST security, allows you to select the password credentials (protocol) or your token card ID for authentication: <ul style="list-style-type: none"> • MSCHAPv2 (default) • PAP (TTLS only) • EAP/MSCHAPv2 • EAP/MD5 • EAP/GTC • EAP/TLS 	For LEAP, PEAP, TTLS, or EAP-FAST security, allows you to select the password credentials (protocol) or your token card ID for authentication: <ul style="list-style-type: none"> • MSCHAPv2 (default, automatically set when EAP_TYPE is set to TTLS) • EAP/MSCHAPv2 (automatically set when EAP_TYPE is set to PEAP) • PAP (TTLS only)

Wireless Communications Settings Differences (continued)

Setting	Current Radio	New Radio
SSID	<p>Specifies the name of the wireless network.</p> <p>Default: INTERMEC</p>	<p>Specifies the name of the wireless network.</p> <p>When MODE is set to DIRECT, the SSID is prefixed with “DIRECT-xy” where xy are alphanumeric characters randomly generated by the Wi-Fi radio.</p> <p>Default: INTERMEC</p>
MODE	<p>Specifies how the printer communicates with other devices:</p> <ul style="list-style-type: none">• Infrastructure (default): Devices on the network communicate with each other through access points. So, wireless and wired devices can communicate with each other.• Adhoc: Devices on the network communicate without using access points. Ad hoc mode is useful for establishing a network where wireless infrastructure does not exist or where services are not required.	<p>Specifies how the printer communicates with other devices:</p> <ul style="list-style-type: none">• INFRA (default): Devices on the network communicate with each other through access points. So, wireless and wired devices can communicate with each other.• DIRECT: Uses the Wi-Fi Direct® standard to establish peer-to-peer connections without the need for an access point:<ul style="list-style-type: none">• The printer becomes a Wi-Fi Direct Group Owner. The SSID is used to create a device name and postfix so that the print can be seen by both Wi-Fi Direct devices, as well as non Wi-Fi Direct devices.• When you select DIRECT; WEP and WPA are disabled, WPA2 is enabled, and EAP_TYPE is set to OFF (clears any EAP_TYPE setting).

Wireless Communications Settings Differences (continued)

Setting	Current Radio	New Radio
EAP_TYPE	<p>Sets the type of 802.11 network authentication on the printer:</p> <ul style="list-style-type: none"> • None • WEP • Pre-Shared Key • PEAP • TLS • TTLS • LEAP • EAP-FAST 	<p>Sets the type of 802.1x network authentication on the printer:</p> <ul style="list-style-type: none"> • OFF (default) • PEAP • TTLS • LEAP • EAP-FAST • EAP-TLS
.SERVER_CN1	<p>When SECURITY TYPE is set to TTLS or PEAP, specifies the name of the certificate on the primary authentication server. If .SERVER_CN1 is not set, .SERVER_CN2 is used. If .SERVER_CN2 is also not set, any common name is accepted.</p>	Not Supported
.SERVER_CN2	<p>When SECURITY TYPE is set to TTLS or PEAP, specifies the name of the certificate on the primary authentication server.</p>	Not Supported
TTLS_USER	<p>When SECURITY TYPE is set to TTLS, sets the TTLS out name.</p>	Not Supported
WPA, WPA2, or WPA/WPA2_MIXED	<p>WPA enables the WPA security mode, and WPA2 enables the WPA2 security mode.</p>	<p>WPA enables the WPA security mode, and WPA2 enables the WPA2 security mode.</p> <p>WPA/WPA2_MIXED enables mixed WPA/WPA2 security mode, so the printer can connect to the access point in either WPA mode or WPA2 mode. This mode is backward compatible with WPA.</p>

Accessories

You can use these accessories with the printer. To order accessories, contact your local Intermec sales representative.

AB27 Battery

Use the 7.4 V 2300 mAh lithium-ion battery to provide power to the printer.

Power Supply (Model AE19)

Provides power to the printer and the 4-bay battery charger (Model AC18).

AC18 4-Bay Battery Charger

Use the AC18 to charge up to four batteries at a time. The battery charger is designed to sense when a battery is fully charged and not overcharge it, ensuring long and consistent battery life.

AV14 Vehicle Dock

Use the vehicle dock to attach the printer to a truck.

Cart Mount

Stands the printer vertically when placed on a flat surface. Excellent for cart or desktop use.

Belt Clip

Use the printer belt clip to attach the printer to your belt.

Handstrap

Use the PB42 and printer handstrap to conveniently carry your printer. With the handstrap attached, you can also attach the shoulder strap.

Media

You can use tag, label, or receipt media with the printer. Printer media does not ship in the box with the printer but may be purchased from www.intermec.com.

Media Core

Use the media core to hold the media in place. The 0.75 inch media core ships with the printer. You can also order the 0.4 inch media core separately.

Intermec Cleaning Swab

Use the Intermec cleaning swab (P/N AE26034) to clean the printhead and platen roller. One cleaning swab is included with the printer. You can purchase additional cleaning swabs from www.intermec.com.

Cleaning Pen

Use the cleaning pen (P/N 757150) to clean the printhead.

Protective Case

Use the protective case to transport and store your printer. The protective case keeps the printer free of dust, dirt, and moisture and still provides easy access to the printer for printing.

Shoulder Strap

Use the shoulder strap in combination with the handstrap to easily carry the printer. The wide padded strap makes it comfortable to wear the printer for long periods of time

Serial Cable

The serial adapter is an 8-pin DIN to DB9 connector that connects from the printer to your desktop PC.

B

Default Settings

Factory Default Settings (Fingerprint Printers)

Factory Default Settings for Fingerprint Printers

Setting	Default Value
Xstart	0
Display	
Orientation	Normal
Contrast	Medium
Media	
Width	Printhead width
Length	1200
Test feed mode	Fast
Type	Variable length strip
Contrast	0%
Xstart	0
Label constant	80
Label factor	40
Print definitions	
Clip default	Off
Print speed	75 mm/s
Feed adjust	
Start adjust	0
Stop adjust	0
Power	
Low battery indicator	7.4 V
Sleep timer	20 sec
Standby timer	30 min

Factory Default Settings for Fingerprint Printers (continued)

Setting	Default Value
Bluetooth	
Discoverable	Enable
Connectable	Enable
Encryption	Disable
Authentication	Disable
Reserve printer	Disable
Device name	1-16 characters
Passcode	1234

Factory Default Settings (IPL Printers)**Factory Default Settings for IPL Printers**

Setting	Default Value
Auto detect printer	Enable
Display	
Orientation	Normal
Contrast	Medium
Print engine emulation mode	None
Media	
Form adjust dots X	0
Form adjust dots Y	0
Test feed mode	Fast
Media type	Continuous
Darkness	0
Sensitivity	180
Print speed	3 ips
Power	
Low battery indicator	7.4 V
Sleep timer	20 sec
Standby timer	30 min

Factory Default Settings for IPL Printers (continued)

Setting	Default Value
Ser-Com	
Baud rate	115200
Data bits	8
Parity	None
Stop bits	1
Protocol	XON/XOFF
Network	
IP selection	DHCP and BOOTP
IP address	0.0.0.0
Netmask	0.0.0.0
Default router	0.0.0.0
Name server	0.0.0.0
MAC address	Unique
Bluetooth	
Discoverable	Enable
Connectable	Enable
Encryption	Disable
Authentication	Disable
Reserve printer	Disable
Device name	1-16 characters
Passcode	1234

Factory Default Settings (ESC/P Printers)

Factory Default Settings for ESC/P Printers

Setting	Default Value
Auto detect printer	Enable
Media dark adjust	100
Print speed	75 mm/s

Factory Default Settings for ESC/P Printers (continued)

Setting	Default Value
Power	
Low battery indicator	7.4 V
Sleep timer	20 sec
Standby timer	30 min
Bluetooth	
Discoverable	Enable
Connectable	Enable
Encryption	Disable
Authentication	Disable
Reserve printer	Disable
Device name	1-16 characters
Passcode	1234
Serial-Com	
Baud rate	115200
Data bits	8
Parity	None
Stop bits	1
Protocol	XON/XOFF
# Network	
IP selection	DHCP and BOOTP
IP address	0.0.0.0
Netmask	0.0.0.0
Default router	0.0.0.0
Name server	0.0.0.0
MAC address	Unique

Appendix B – Default Settings

C

IPL and Fingerprint Setup Menus

IPL Setup Menu

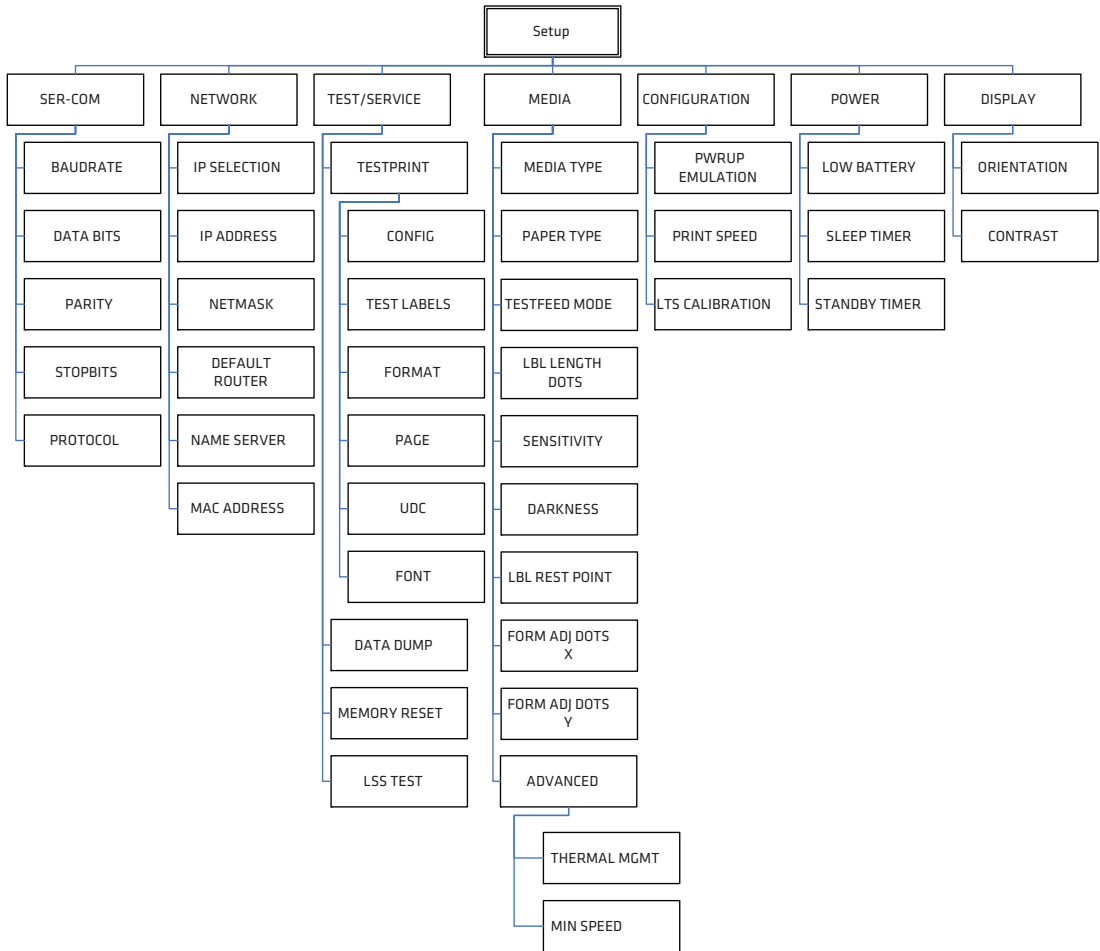

Fingerprint Setup Menu

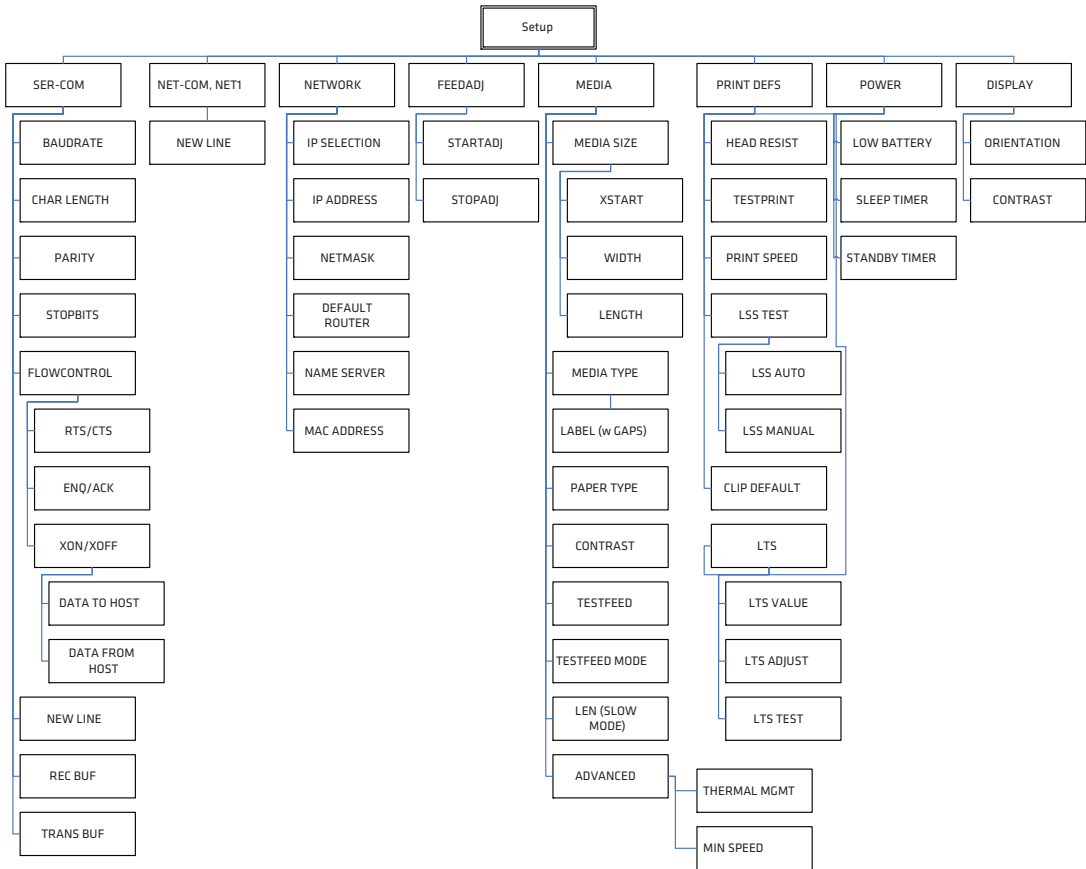

Appendix C – IPL and Fingerprint Setup Menus



Index

Numerics

- 802.11
 - determining which radio is installed 33
 - setting up communications 33
 - wireless communications settings, differences 63

A

- AB27 battery 66
- AC18 battery charger 12, 66
- accessories
 - AB27 battery 66
 - AC18 battery charger 66
 - AV14 vehicle dock 66
 - belt clip 66
 - cart mount 66
 - handstrap 66
 - power supply 66
 - serial cable 67
 - shoulder strap 67
- AV14 vehicle dock 66

B

- backlight, understanding 10
- batteries
 - AC18 charger 12
 - charging 12
 - charging time 10
 - extending life 13
 - installing 10, 11
 - status icons 13
 - using 10
- Bluetooth communications 31
- button functions 4

C

- cleaning the printer 52
- cold booting 52
- communication problems 50
 - using Dump mode in IPL 51
 - using the line analyzer in Fingerprint 50
- communications
 - setting up 802.11 radio communications 33
 - setting up Bluetooth radio communications 31

- configuration settings
 - changing from printer home page 35
 - changing using the command line 35
 - changing with PrintSet 35
 - changing with SmartSystems 36, 41
 - display modes 19
 - how to change 34
- connecting to the printer using USB 28
- control panel features 3

D

- default settings
 - ESC/P printers 72
 - Fingerprint printers 70, 71
- display modes
 - error 22
 - information 19
 - pause 20
 - ready 19
 - setup 20
 - test 22
- downloading fonts and graphics 44

E

- error messages and icons
 - door open 48
 - field out of label 47
 - IP configuration error 47
 - IP link error 47
 - LSS too high/low 47
 - out of paper 47
 - pause 47
 - printhead hot 47
 - upgrading 47
- Error mode 22
- ESC/P
 - changing printer language 8
 - default settings 72
 - setup commands 25

F

- Fingerprint
 - changing printer language 7
 - default settings 70, 71
 - setup menu 24, 77
- firmware upgrade, cold booting 52

- H**
HyperTerminal
 sending printer commands 35
 upgrading firmware 41
 viewing IPL commands 35
- I**
Information mode 19
IPL
 changing printer language 7
 setup commands 25
 setup menu 76
 viewing commands as you type 35
- L**
language, see printer language
load media 14
- M**
Magnetic Stripe Reader 16
media
 loading 14
 recommended sensitivity and constant 60
 supported 60
media specifications 59
- P**
Pause mode 20
power specifications 58
print speed and resolution 59
printer
 backlight 10
 charging batteries 12
 cleaning 52
 cold booting 52
 communication problems 50
 configuring 34
 control panel 3
 default settings 70, 71
 downloading fonts and graphics 44
 features 2
 home page 35
 languages, choosing 6
 loading media 14
 memory 58
 parts 2
 printing a test page 26
 Ready-to-Work indicator 5
 soft keys 5
 sounds, understanding 9
 troubleshooting problems 48
 using the batteries 10
 using the buttons 4
Printer Home Page, upgrading firmware 38
printer language
 changing using ESC/P 8
 changing using Fingerprint 7
 changing using IPL 7
 changing using PrintSet 7
PrintSet
 changing configuration settings 35
 changing printer language 7
 downloading fonts and graphics 44
 upgrading firmware 37
- R**
Ready mode 19
Ready-to-Work indicator states 5
- S**
setup commands
 ESC/P 25
 IPL 25
setup menu
 Fingerprint 24, 77
 IPL 76
Setup mode 20
Smart Card Reader 17
SmartSystems, changing configuration settings 36, 41
soft keys, using 5
sounds, status 9
specifications
 external fanfold media 60
 media 59
 memory 58
 power 58
 print speed and resolution 59
 print technology 59
 supported media 60
 temperature and humidity 58
- T**
temperature and humidity specifications 58
Test mode 22
test page, printing 26

Index

troubleshooting
 communication problems 50
 contacting product support 46
 error messages 46
 printer problems and
 solutions 48
 using Dump mode in IPL 51
 using the line analyzer in
 Fingerprint 50

U

upgrading firmware
 using HyperTerminal 41
 using Printer Home Page 38
 using PrintSet 37
USB, connecting to the printer 28

W

wireless communications settings,
 differences 63



Worldwide Headquarters
6001 36th Avenue West
Everett, Washington 98203
U.S.A.

tel 425.348.2600

fax 425.355.9551

www.intermec.com

© 2013 Intermec Technologies
Corporation. All rights reserved.

PB21 and PB31 Mobile Receipt Printer User Guide



P/N 934-051-004